

Modular, Flexible, Strong. With over 50 configurations, MFS sets up just the way you want it and rearranges easily without tools. With unmatched durability, MFS is solid construction built to be climbed on.



## MFS and MFS Renew

Both MFS and MFS Renew offer the same features and benefits and are interchangeable with each other. The only difference is the removal of the decorative solid wood corner joint to create the MFS Renew furniture pieces. This results in a more streamlined aesthetic and a lower price option.



MFS



MFS Renew

## Features

### Shared Features

#### Modular components that stack

Components build off each other to create traditional or lofted layouts using the same pieces. Every piece is 29" high making it simple to understand and reconfigure.

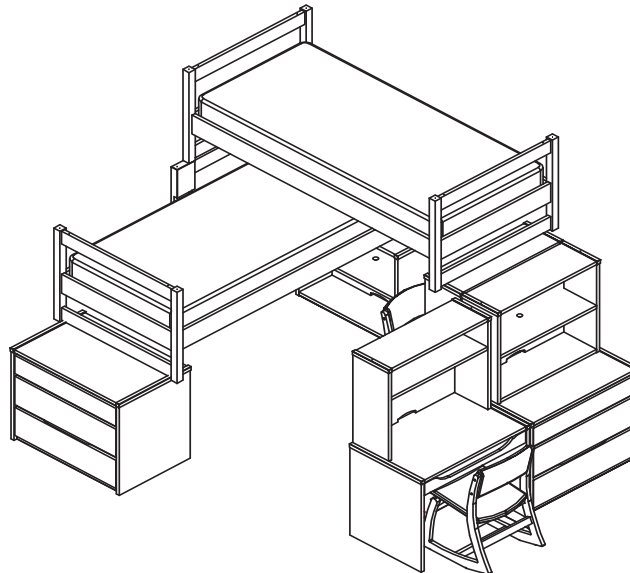

#### No tools to reconfigure

Utilizes a steel pin-and-hole system to keep furniture properly positioned and stable. It is designed to be simple so it can be reconfigured quickly, easily and safely with no tools or help from staff.

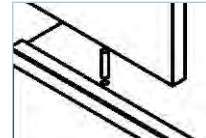

## Features

### Bed

#### Construction

Solid wood posts, 1" hardwood veneer plywood rails. Uses glue and dowel construction with metal-to-metal connections for simple, quick, durable assembly.

#### Bunk and stack.

Steel pins at each post allow for bunking and lofting without tools.

#### Side return rail.

Supports trundled configurations.

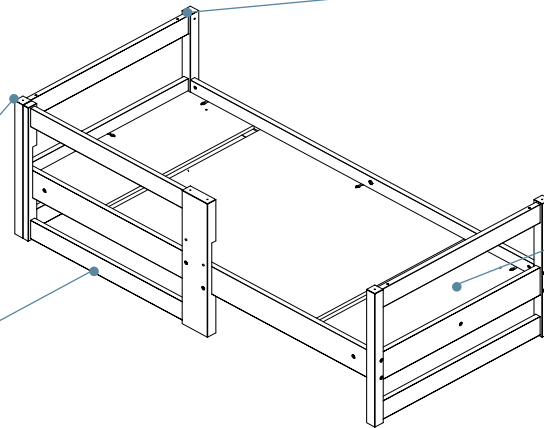

#### 7 bed heights.

Beds can be placed on the floor, bunked or stacked on top of furniture to create trundled or lofted layouts. The bed frame is flippable providing two different deck height options.

#### Bed deck.

3-piece wood deck is fixed height.

### Desk

#### Construction

Glue and dowel assembly with reinforced cleats.

1" hardwood veneer plywood sides with 3/4" hardwood veneer back panel and matching PVC edge band. Laminate work surface with matching PVC edge band.

Drawers have 3/4" veneer removable fronts, 1/2" veneer plywood sides and 1/4" bottom with waterproof vinyl face; dove-tail joinery; and open to 3/4 of their depth.

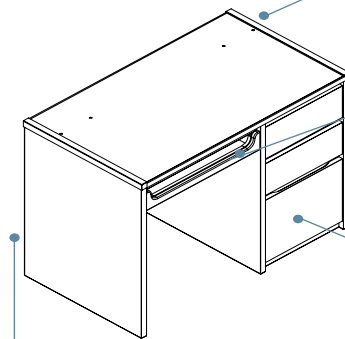

#### Back panel.

3/4 height for access to wall outlets and easy cable routing.

#### Stackable.

Top is drilled to accept steel mounting pins for stacking components.

#### Computer or pencil drawer.

Keeps supplies organized and within reach. Computer drawer (shown) has a cutout to access keyboard.

#### Configurations.

Box drawers, file drawer, open and closed shelves. Desk shell with no storage is also available. Drawers have 3/4 extension epoxy coated slides.

#### Optional Hasp Lock

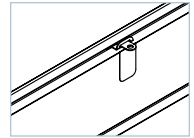

Available on top drawer only. Use with own padlock to provide additional security.

## Features

### Organizer

#### Construction

Glue and dowel assembly

1" hardwood veneer plywood sides, top, and shelf with 3/4" hardwood veneer back panel and matching PVC edge band.

#### Task light option.

Mounts in the recessed area beneath shelf. Choice of fluorescent or energy efficient LED.

#### Back panel.

Full height below shelf, open above shelf.

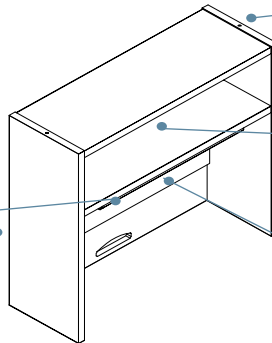

#### Stackable.

Top is drilled to accept steel mounting pins for stacking components.

#### Cable management.

Cable egress hole in back panel at bottom. Back panel and fixed shelf have cord management cutouts for easy cable routing.

#### Optional tack board.

Provides a place to display personal items.

### Chest

#### Construction

Glue and dowel assembly, with reinforced cleats.

1" hardwood veneer plywood sides with 3/4" hardwood veneer back panel and matching PVC edge band. Laminate top with matching PVC edge band.

Drawers have 3/4" veneer plywood removable fronts, 1/2" veneer plywood sides and 1/4" bottom with waterproof vinyl face; dove-tail joinery; and open to 3/4 of their depth.

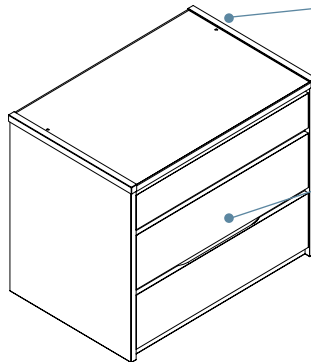

#### Stackable.

Top and bottom are drilled to accept steel mounting pins for stacking components.

#### Drawers.

3/4 extension epoxy coated slides.

#### Optional Hasp Lock

See Desk feature section for additional details.

## Features

### Bookcase

#### Construction

Glue and dowel assembly

1" hardwood veneer plywood sides, top, and shelf with 3/4" hardwood veneer back panel and matching PVC edge band.

#### Security Bookcase Option

Features a Hasp Lock with a single lockable door to keep items secure.

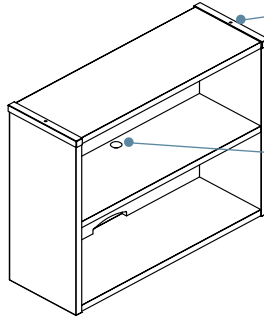

#### Stackable.

End panels are drilled at top and bottom to accept steel mounting pins for stacking components.

#### Cable management.

For easy cable routing, the bookcase features a cable egress hole in back panel at bottom and cord cutout at fixed shelf.

### Wardrobe

#### Construction

Glue and dowel assembly

1" hardwood veneer plywood sides with 3/4" hardwood veneer back panel and matching PVC edge band.

Drawers have 3/4" veneer plywood removable front, 1/2" veneer plywood sides and 1/4" bottom with waterproof vinyl face; dove-tail joinery; and open to 3/4 of their depth.

#### Configurations

Available in either 2-doors or 2-doors with 2-drawers.

#### Optional J-bar

Supports bed in lofted configuration.

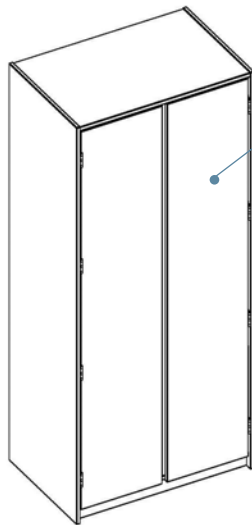

#### Interior.

Coat rod and coat hook. Two-door unit has fixed shelf above coat rod. Optional, 14"w x 24"l mirror hangs on inside of door.

#### Leveler glides.

4 adjustable glides accommodate uneven floors.

#### Drawers

3/4 extension epoxy coated slides.

#### Optional Hasp Lock

Available on 2-drawer unit. See Desk feature section for additional details.

## Statement of Line

---



Bed



Desk



Desk with Organizer



Chest



Bookcase

Product not shown: Wardrobe

## How to Specify

---

Example.      1. Model Number/Size      2. Species and Finish

**MFOR1A1234**      **K02**

Step 1.      Identify the Part Number from the succeeding product price pages.

Step 2.      Select the Species and Finish:

**K** Oak  
02 Light  
40 Medium

**M** Maple  
01 Natural  
42 Cherry  
60 Cocoa  
76 Mocha

## Configurations

Modular furniture can be arranged just about any way you want it with 50+ different configurations. It is simple to rearrange without tools or staff help, making it the right choice for everyone.

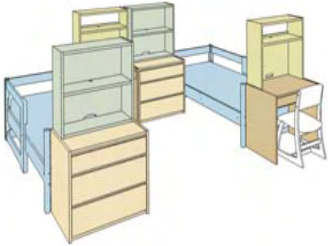

Double, on the floor.

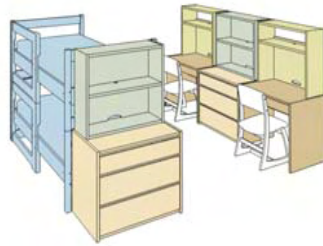

Double, bunked.

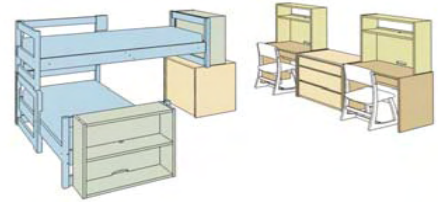

Double, trundled.



Double, raised trundled.

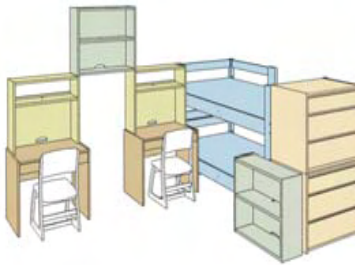

Double, bunked.

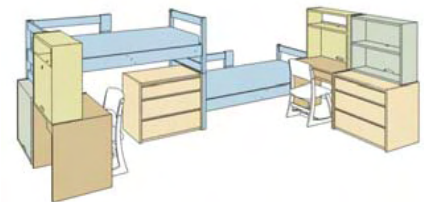

Double, staggered stack.

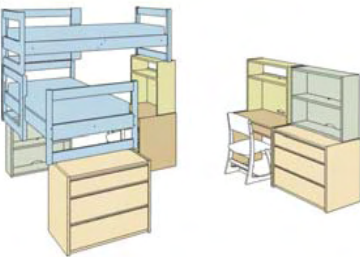

Double, raised trundled.

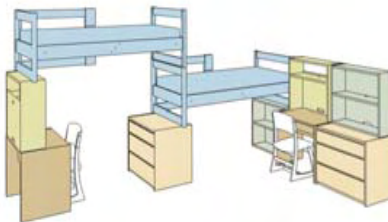

Double, raised staggered stack.

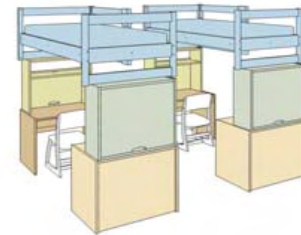

Double, high loft.

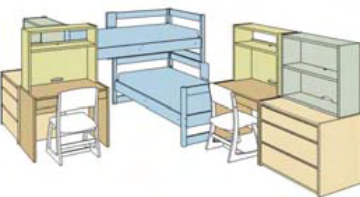

Double, trundled.



Triple, bunked and trundled.



Triple, staggered stack and trundled.

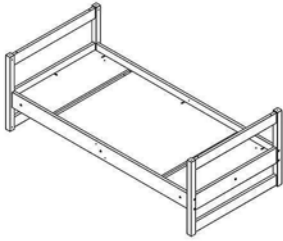

71-204

**Standard includes:**

- Solid wood posts, veneer plywood rails with matching PVC edge band
- Species: **K** Oak or **M** Maple
- 4 steel pins to reconfigure with no tools
- Deck: 3-piece wood
- Fits mattress size: 36x80
- Shipped ready to assemble

Part Number	Description	D" x W" x H"	Price
MFBE3W4184-K	MFS, Bed, 3-Piece Deck, 3 Rail, Sized for 36 X 80 Mattress	41 x 84 x 29	\$642
MFBE3W4184-M	MFS, Bed, 3-Piece Deck, 3 Rail, Sized for 36 X 80 Mattress	41 x 84 x 29	\$674

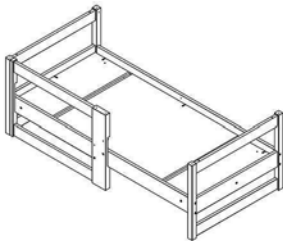

71-204

Tip: side return rail supports trundled configurations

**Standard includes:**

- Solid wood posts, veneer plywood rails with matching PVC edge band
- Side return rail
- Species: **K** Oak or **M** Maple
- 4 steel pins to reconfigure with no tools
- Deck: 3-piece wood
- Fits mattress size: 36x80
- Shipped ready to assemble

Part Number	Description	D" x W" x H"	Price
MFBE3R4184-K	MFS, Bed W/ Side Return, 3-Piece Deck, 3 Rail, Sized for 36 X 80 Mattress	41 x 84 x 29	\$796
MFBE3R4184-M	MFS, Bed W/ Side Return, 3-Piece Deck, 3 Rail, Sized for 36 X 80 Mattress	41 x 84 x 29	\$836



71-204

**Standard includes:**

- 1 " exposed veneer plywood
- Species: **K** Oak or **M** Maple
- Each step supported beneath by threaded metal rod
- Available in 2 sizes for bunked or lofted layouts

Part Number	Description	D" x W" x H"	Price
MFLD1X313-K	MFS, MFS Ladder for Bunked Beds	3 x 13 x 68	\$244
MFLD1X313-M	MFS, MFS Ladder for Bunked Beds	3 x 13 x 68	\$250
MFLD2X313-K	MFS, MFS Ladder for Lofted Beds	3 x 13 x 81	\$278
MFLD2X313-M	MFS, MFS Ladder for Lofted Beds	3 x 13 x 81	\$284

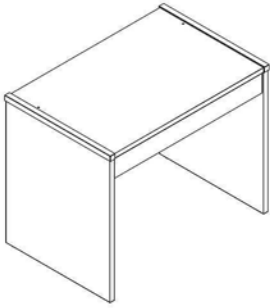

71-204

Tip: Computer drawer has a cutout on drawer front

**Standard includes:**

- Case: hardwood veneer plywood with matching PVC edge band
- Worksurface: laminate with matching PVC edge band
- Solid wood corner joiners
- Species: **K** Oak or **M** Maple
- 3/4 height back panel
- Pencil or computer drawer
- 3/4 extension epoxy coated drawer slides
- Shipped assembled

Part Number	Description	D" x W" x H"	Price
MFDEBB2436-K	MFS, Desk, Slab Leg, Pencil Drawer	24 x 36 x 29	\$608
MFDEBB2436-M	MFS, Desk, Slab Leg, Pencil Drawer	24 x 36 x 29	\$620
MFDEBB2442-K	MFS, Desk, Slab Leg, Pencil Drawer	24 x 42 x 29	\$700
MFDEBB2442-M	MFS, Desk, Slab Leg, Pencil Drawer	24 x 42 x 29	\$714
MFDEBB2448-K	MFS, Desk, Slab Leg, Pencil Drawer	24 x 48 x 29	\$732
MFDEBB2448-M	MFS, Desk, Slab Leg, Pencil Drawer	24 x 48 x 29	\$746
MFDEBC2436-K	MFS, Desk, Slab Leg, Computer Drawer	24 x 36 x 29	\$626
MFDEBC2436-M	MFS, Desk, Slab Leg, Computer Drawer	24 x 36 x 29	\$640
MFDEBC2442-K	MFS, Desk, Slab Leg, Computer Drawer	24 x 42 x 29	\$724
MFDEBC2442-M	MFS, Desk, Slab Leg, Computer Drawer	24 x 42 x 29	\$736
MFDEBC2448-K	MFS, Desk, Slab Leg, Computer Drawer	24 x 48 x 29	\$758
MFDEBC2448-M	MFS, Desk, Slab Leg, Computer Drawer	24 x 48 x 29	\$774

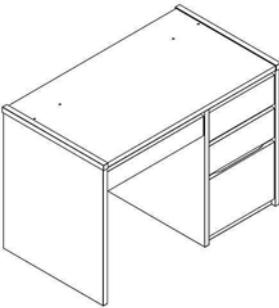

71-204

**Standard includes:**

- Desk case: hardwood veneer plywood with matching PVC edge band
- Worksurface: laminate with matching PVC edge band
- Solid wood corner joiners
- Species: **K** Oak or **M** Maple
- 3/4 height back panel
- Pencil or computer drawer
- Box/ Box/ File
- 3/4 extension epoxy coated drawer slides
- Shipped assembled

**Options available:**

- Hasp lock on top drawer, only; black

Part Number	Description	D" x W" x H"	Price	Drawer Hasp
MFDEBJ2442-K	MFS, Desk, Slab Leg, BBF, Pencil Drawer	24 x 42 x 29	\$1,006	+\$35
MFDEBJ2442-M	MFS, Desk, Slab Leg, BBF, Pencil Drawer	24 x 42 x 29	\$1,024	+\$35
MFDEBJ2448-K	MFS, Desk, Slab Leg, BBF, Pencil Drawer	24 x 48 x 29	\$1,046	+\$35
MFDEBJ2448-M	MFS, Desk, Slab Leg, BBF, Pencil Drawer	24 x 48 x 29	\$1,066	+\$35
MFDEBK2442-K	MFS, Desk, Slab Leg, BBF, Computer Drawer	24 x 42 x 29	\$1,032	+\$35
MFDEBK2442-M	MFS, Desk, Slab Leg, BBF, Computer Drawer	24 x 42 x 29	\$1,050	+\$35
MFDEBK2448-K	MFS, Desk, Slab Leg, BBF, Computer Drawer	24 x 48 x 29	\$1,072	+\$35
MFDEBK2448-M	MFS, Desk, Slab Leg, BBF, Computer Drawer	24 x 48 x 29	\$1,092	+\$35

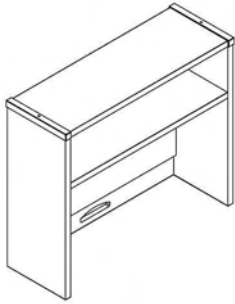

71-204

**Standard includes:**

- Hardwood veneer plywood with matching PVC edge band
- Solid wood corner joiners
- Species: **K** Oak or **M** Maple
- Cable management cutouts
- Fixed shelf
- Shipped assembled

**Options available:**

- Tack board
- Task light: Florescent or LED

Part Number	Description	D" x W" x H"	Price	Tack	Light	LED
MFOR1X1234-K	MFS, Organizer, High Shelf	12 x 34 x 29	\$394	+\$50	+\$100	+\$187
MFOR1X1234-M	MFS, Organizer, High Shelf	12 x 34 x 29	\$402	+\$50	+\$100	+\$187
MFOR1X1240-K	MFS, Organizer, High Shelf	12 x 40 x 29	\$410	+\$50	+\$100	+\$187
MFOR1X1240-M	MFS, Organizer, High Shelf	12 x 40 x 29	\$420	+\$50	+\$100	+\$187

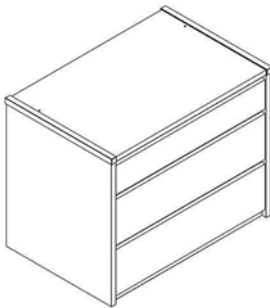

71-204

**Standard includes:**

- Case: hardwood veneer plywood with matching PVC edge band
- Top: laminate with matching PVC edge band
- Solid wood corner joiners
- Species: **K** Oak or **M** Maple
- 3/4 extension epoxy coated drawer slides
- Shipped assembled

**Options available:**

- Hasp lock on top drawer, only; black

Part Number	Description	D" x W" x H"	Price	Drawer Hasp
MFDR3X2436-K	MFS, Chest, 3-Drawer	24 x 36 x 29	\$952	+\$35
MFDR3X2436-M	MFS, Chest, 3-Drawer	24 x 36 x 29	\$972	+\$35

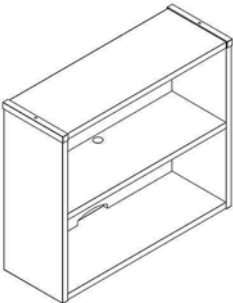

71-204

**Standard includes:**

- Hardwood veneer plywood with matching PVC edge band
- Solid wood corner joiners
- Species: **K** Oak or **M** Maple
- Cable management cutouts
- Fixed shelf
- Shipped assembled

Part Number	Description	D" x W" x H"	Price
MFBK1S1234-K	MFS, Bookcase, 1-Shelf	12 x 34 x 29	\$404
MFBK1S1234-M	MFS, Bookcase, 1-Shelf	12 x 34 x 29	\$412

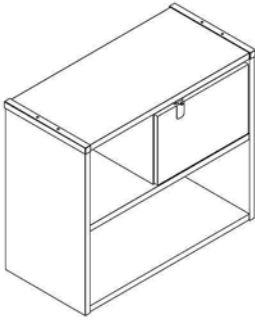

71-204

**Standard includes:**

- Hardwood veneer plywood with matching PVC edge band
- Solid wood corner joints
- Species: **K** Oak or **M** Maple
- Cable management: cutout in back panel
- Fixed shelves
- Single lockable door; hasp lock: black
- Shipped assembled

Part Number	Description	D" x W" x H"	Price
MFBKSC1234-K	MFS, Security Bookcase	12 x 34 x 29	\$578
MFBKSC1234-M	MFS, Security Bookcase	12 x 34 x 29	\$600

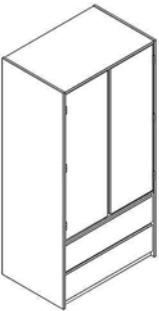

71-204

Tip: two door model features fixed shelf above closet rod

**Standard includes:**

- Hardwood veneer plywood with matching PVC edge band
- Species: **K** Oak or **M** Maple
- Closet rod: chrome
- Coat hook on inside of door
- 3/4 extension epoxy coated drawer slides, if specified
- Shipped assembled

**Options available:**

- Hasp lock on top drawer, only; black
- J-bar for lofting of bed
- Mirror, 14w x 24l
- Towel bar

Part Number	Description	D" x W" x H"	Price	Mirror	TwlBar	Jbar	Drawer Hasp
MFWABP2436-K	MFS Wardrobe, 2 Door, Coat Hook	24 x 36 x 72	\$1,140	+\$50	+\$43	+\$68	
MFWABP2436-M	MFS Wardrobe, 2 Door, Coat Hook	24 x 36 x 72	\$1,184	+\$50	+\$43	+\$68	
MFWACG2436-K	MFS, 72" Wardrobe, 2 Door, 2 Drawer	24 x 36 x 72	\$1,320	+\$50	+\$43	+\$68	+\$35
MFWACG2436-M	MFS, 72" Wardrobe, 2 Door, 2 Drawer	24 x 36 x 72	\$1,458	+\$50	+\$43	+\$68	+\$35

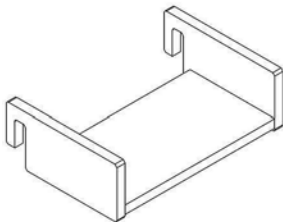

71-204

**Standard includes:**

- Laminated veneer exposed plywood panels
- Species: **K** Oak or **M** Maple
- Position anywhere along headboard and side rail

Part Number	Description	D" x W" x H"	Price
MFSHTX815-K	MFS, Talon Shelf, 15"	15 x 8 x 5	\$72
MFSHTX815-M	MFS, Talon Shelf, 15"	15 x 8 x 5	\$74
MFSHTX823-K	MFS, Talon Shelf, 23"	23 x 8 x 5	\$88
MFSHTX823-M	MFS, Talon Shelf, 23"	23 x 8 x 5	\$90

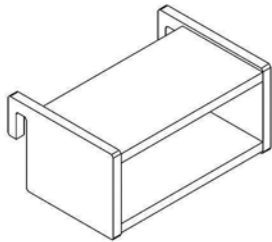

71-204

**Standard includes:**

- Laminated veneer exposed plywood panels
- Species: **K** Oak or **M** Maple
- Position anywhere along headboard and side rail

Part Number	Description	D" x W" x H"	Price
MFSHTB815-K	MFS, Talon Box Shelf, 15"	8 x 15 x 7	\$108
MFSHTB815-M	MFS, Talon Box Shelf, 15"	8 x 15 x 7	\$110
MFSHTB823-K	MFS, Talon Box Shelf, 23"	23 x 8 x 7	\$118
MFSHTB823-M	MFS, Talon Box Shelf, 23"	23 x 8 x 7	\$120

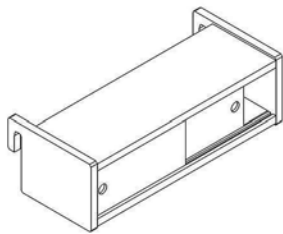

71-204

**Standard includes:**

- Laminated veneer exposed plywood panels
- Door front: white laminate
- Species: **K** Oak or **M** Maple
- Center divider
- Position anywhere along headboard and side rail

Part Number	Description	D" x W" x H"	Price
MFSHTS0823-K	MFS, Talon Box Shelf with Sliding Doors	23 x 8 x 7	\$128
MFSHTS0823-M	MFS, Talon Box Shelf with Sliding Doors	23 x 8 x 7	\$132

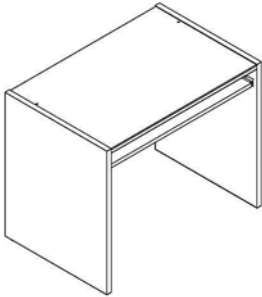

71-204

**Standard includes:**

- Case: hardwood veneer plywood with matching PVC edge band
- Worksurface: laminate with matching PVC edge band
- Species: **K** Oak or **M** Maple
- 3/4 height back panel
- Pencil or keyboard tray
- Shipped assembled

Part Number	Description	D" x W" x H"	Price
MRDEBA2436-K	MFS RENEW, Desk, Slab Leg, Keyboard Tray	24 x 36 x 29	\$468
MRDEBA2436-M	MFS RENEW, Desk, Slab Leg, Keyboard Tray	24 x 36 x 29	\$478
MRDEBA2442-K	MFS RENEW, Desk, Slab Leg, Keyboard Tray	24 x 42 x 29	\$552
MRDEBA2442-M	MFS RENEW, Desk, Slab Leg, Keyboard Tray	24 x 42 x 29	\$560
MRDEBA2448-K	MFS RENEW, Desk, Slab Leg, Keyboard Tray	24 x 48 x 29	\$578
MRDEBA2448-M	MFS RENEW, Desk, Slab Leg, Keyboard Tray	24 x 48 x 29	\$590
MRDEBB2436-K	MFS RENEW, Desk, Slab Leg, Pencil Drawer	24 x 36 x 29	\$532
MRDEBB2436-M	MFS RENEW, Desk, Slab Leg, Pencil Drawer	24 x 36 x 29	\$542
MRDEBB2442-K	MFS RENEW, Desk, Slab Leg, Pencil Drawer	24 x 42 x 29	\$614
MRDEBB2442-M	MFS RENEW, Desk, Slab Leg, Pencil Drawer	24 x 42 x 29	\$626
MRDEBB2448-K	MFS RENEW, Desk, Slab Leg, Pencil Drawer	24 x 48 x 29	\$642
MRDEBB2448-M	MFS RENEW, Desk, Slab Leg, Pencil Drawer	24 x 48 x 29	\$656

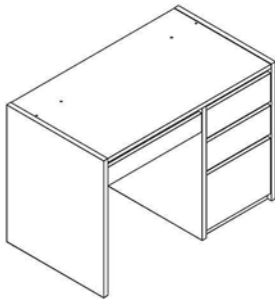

71-204

**Standard includes:**

- Case: hardwood veneer plywood with matching PVC edge band
- Worksurface: laminate with matching PVC edge band
- Species: **K** Oak or **M** Maple
- 3/4 height back panel
- Pencil or keyboard tray
- Box/ Box/ File
- 3/4 extension epoxy coated drawer slides
- Shipped assembled

**Options available:**

- Hasp lock on top drawer, only; black

Part Number	Description	D" x W" x H"	Price	Drawer Hasp
MRDEBI2442-K	MFS RENEW, Desk, Slab Leg, BBF, Keyboard Tray	24 x 42 x 29	\$868	+\$35
MRDEBI2442-M	MFS RENEW, Desk, Slab Leg, BBF, Keyboard Tray	24 x 42 x 29	\$886	+\$35
MRDEBI2448-K	MFS RENEW, Desk, Slab Leg, BBF, Keyboard Tray	24 x 48 x 29	\$904	+\$35
MRDEBI2448-M	MFS RENEW, Desk, Slab Leg, BBF, Keyboard Tray	24 x 48 x 29	\$922	+\$35
MRDEBJ2442-K	MFS RENEW, Desk, Slab Leg, BBF, Pencil Drawer	24 x 42 x 29	\$932	+\$35
MRDEBJ2442-M	MFS RENEW, Desk, Slab Leg, BBF, Pencil Drawer	24 x 42 x 29	\$950	+\$35
MRDEBJ2448-K	MFS RENEW, Desk, Slab Leg, BBF, Pencil Drawer	24 x 48 x 29	\$968	+\$35
MRDEBJ2448-M	MFS RENEW, Desk, Slab Leg, BBF, Pencil Drawer	24 x 48 x 29	\$988	+\$35

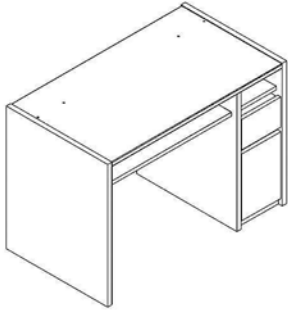

71-204

**Standard includes:**

- Case: hardwood veneer plywood with matching PVC edge band
- Worksurface: laminate with matching PVC edge band
- Species: **K** Oak or **M** Maple
- 3/4 height back panel
- Phat Leg A or Phat Leg C configuration
- 3/4 extension epoxy coated drawer slides
- Shipped assembled

**Configurations:**

- Phat Leg C: mouse tray, CD storage drawer, Deep drawer (as shown)
- Phat Leg D: Pencil drawer, CD drawer, Deep drawer

Part Number	Description	D" x W" x H"	Price
MRDEBS2436-K	MFS RENEW, Desk, Slab Leg, Phat Leg C	24 x 36 x 29	\$770
MRDEBS2436-M	MFS RENEW, Desk, Slab Leg, Phat Leg C	24 x 36 x 29	\$786
MRDEBS2442-K	MFS RENEW, Desk, Slab Leg, Phat Leg C	24 x 42 x 29	\$800
MRDEBS2442-M	MFS RENEW, Desk, Slab Leg, Phat Leg C	24 x 42 x 29	\$816
MRDEBV2436-K	MFS RENEW, Desk, Slab Leg, Phat Leg D	24 x 36 x 29	\$800
MRDEBV2436-M	MFS RENEW, Desk, Slab Leg, Phat Leg D	24 x 36 x 29	\$816
MRDEBV2442-K	MFS RENEW, Desk, Slab Leg, Phat Leg D	24 x 42 x 29	\$826
MRDEBV2442-M	MFS RENEW, Desk, Slab Leg, Phat Leg D	24 x 42 x 29	\$842

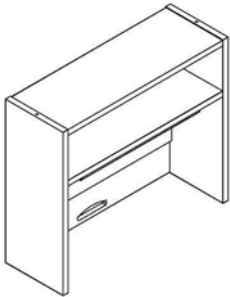

71-204

**Standard includes:**

- Hardwood veneer plywood with matching PVC edge band
- Species: **K** Oak or **M** Maple
- Cable management cutouts
- Fixed shelf
- Shipped assembled

**Options available:**

- Tack board
- Task light: Florescent or LED

Part Number	Description	D" x W" x H"	Price	Tack	Light	LED
MROR1X1234-K	MFS RENEW, Organizer	12 x 34 x 29	\$344	+\$50	+\$100	+\$187
MROR1X1234-M	MFS RENEW, Organizer	12 x 34 x 29	\$352	+\$50	+\$100	+\$187
MROR1X1240-K	MFS RENEW, Organizer	12 x 40 x 29	\$360	+\$50	+\$100	+\$187
MROR1X1240-M	MFS RENEW, Organizer	12 x 40 x 29	\$370	+\$50	+\$100	+\$187

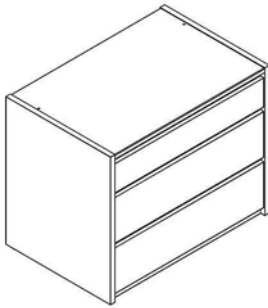

71-204

**Standard includes:**

- Case: hardwood veneer plywood with matching PVC edge band
- Top: laminate with matching PVC edge band
- Species: **K** Oak or **M** Maple
- 3/4 extension epoxy coated drawer slides
- Shipped assembled

**Options available:**

- Hasp lock on top drawer, only; black

Part Number	Description	D" x W" x H"	Price	Drawer Hasp
MRDR3X2436-K	MFS RENEW, Chest, 3-Drawer	24 x 36 x 29	\$886	+\$35
MRDR3X2436-M	MFS RENEW, Chest, 3-Drawer	24 x 36 x 29	\$902	+\$35

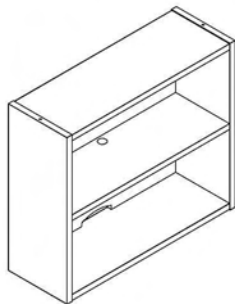

71-204

**Standard includes:**

- Hardwood veneer plywood with matching PVC edge band
- Species: **K** Oak or **M** Maple
- Cable management cutouts
- Fixed shelves
- Shipped assembled

Part Number	Description	D" x W" x H"	Price
MRBK1S1234-K	MFS RENEW, Bookcase, 1-Shelf	12 x 34 x 29	\$350
MRBK1S1234-M	MFS RENEW, Bookcase, 1-Shelf	12 x 34 x 29	\$356

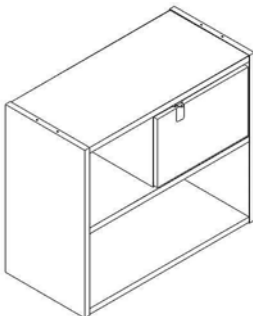

71-204

**Standard includes:**

- Hardwood veneer plywood with matching PVC edge band
- Species: **K** Oak or **M** Maple
- Cable management: cutout in back panel
- Fixed shelves
- Single lockable door; hasp lock
- Shipped assembled

Part Number	Description	D" x W" x H"	Price
MRBKSC1234-K	MFS-RENEW, Security Bookcase	12 x 34 x 29	\$526
MRBKSC1234-M	MFS-RENEW, Security Bookcase	12 x 34 x 29	\$546